

NEWTON LITE 2.6

Technical Details

Dimensions (mm)	80.27 x 43.03 x 14.00	Waterproof	IP52
LED	7 Colors	Battery	1 x CR2450
Display Technology	Full graphic E-ink display	Battery lifetime	10 years (7.000-10.000 updates)
Active display area (mm)	59.85 x 30.49	Encryption	128-bit AES
Resolution (pixels)	360 x 184	Compliance	CE, ROHS, FCC
Pixel density	152 DPI	NFC	FeliCa NFC Forum Type 3
Pixel colors	BW / BWR / BWY	ESL operating frequency	2,4 GHz
Viewing angle	Nearly 180°	Wireless firmware update	Yes
Usable pages	Up to 7 pages		
Operating temperature	0°C to 40°C		

Technical Drawing

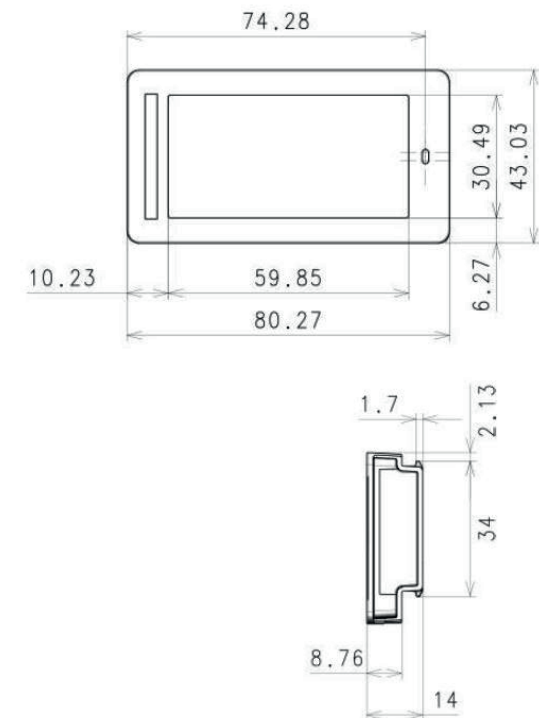

NEWTON LITE 2.6



e-shelf-labels | S&K Solutions GmbH

Sailerwöhr 16 | 94032 Passau
+49 (0) 851 / 2009 30 30

info@e-shelf-labels.com
www.e-shelf-labels.com

a brand of 
solutions