

VUSION 2.6 BWR EU140

Technical Details

Dimensions (mm)	80,0 x 41,1 x 11,4 (without LED and Easylock)	Operating temperature	+10°C to +40°C
Display technology	Full graphic E-ink display	Battery	2 x CR2450
Active display area (mm)	60,1 x 30,7	Battery lifetime	10 years (7.000-10.000 updates)
Resolution (pixels)	296 x 152	Encryption	128-bit AES
Pixel density	125 dpi	Compliance	CE, ROHS, FCC/IC
Pixel colors	Black/white/red	Packaging unit	100 labels/box
Usable pages	5	Active NFC	Yes, operating frequency: 13,56 MHz
Viewing angle	Nearly 180°	Operating frequency	available in 868 MHz or 2.4 GHz
Label updates/h (CE/FCC)	8000 per datachannel, 3 channels max	Wireless firmware update	Yes

Technical Drawing

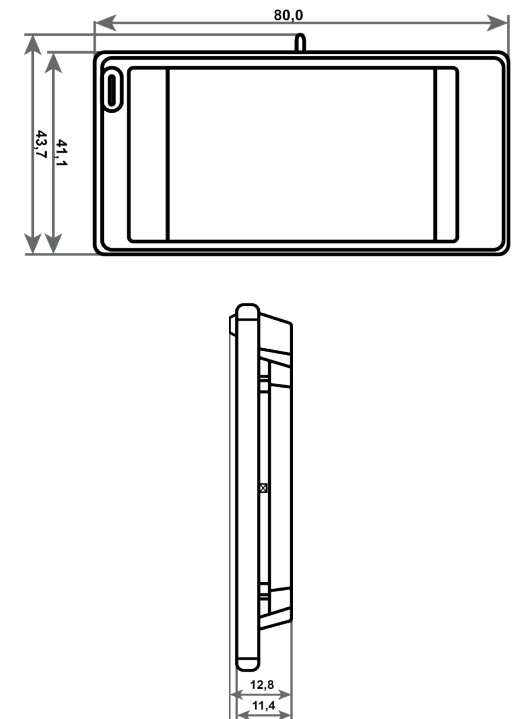

VUSION 2.6 BWR EU140



e-shelf-labels | S&K Solutions GmbH

Sailerwöhr 16 | 94032 Passau
+49 (0) 851 / 2009 30 30

info@e-shelf-labels.com
www.e-shelf-labels.com

a brand of 
solutions